

# OPERATION MANUAL

Air Quality Measuring Device  
**Condair Cube**

**Proprietary Notice**

This document and the information disclosed herein are proprietary data of Condair Group AG. Neither this document, nor the information contained herein shall be reproduced, used, or disclosed to others without the written authorisation of Condair Group AG, except to the extent required for installation or maintenance of recipient's equipment.

**Liability Notice**

Condair Group AG does not accept any liability due to incorrect installation or operation of the equipment or due to the use of parts/components/equipment that are not authorised by Condair Group AG.

**Copyright Notice**

© Condair Group AG, All rights reserved.

Technical modifications reserved.

# Contents

---

<b>1</b>	<b>Introduction</b>	<b>4</b>
1.1	Thank you for purchasing your Condair Cube	4
1.2	Notes on the operation manual	4
<b>2</b>	<b>For your safety</b>	<b>5</b>
<b>3</b>	<b>Quickstart</b>	<b>6</b>
<b>4</b>	<b>Product overview</b>	<b>7</b>
4.1	Components	7
4.2	Main screen view	8
4.2.1	Traffic light display of the measured values	9
4.3	Application overviews	10
4.3.1	View health chart	10
4.3.2	View historical readings	11
4.3.3	Settings	11
<b>5</b>	<b>Calibration</b>	<b>12</b>
5.1	Manual Calibration	12
5.2	Auto calibration	14
<b>6</b>	<b>Time and date setting</b>	<b>15</b>
<b>7</b>	<b>Conversion degrees Celsius / degrees Fahrenheit</b>	<b>17</b>
<b>8</b>	<b>Options</b>	<b>18</b>
8.1	SD card	18
8.2	Power bank	18
8.3	Display on large screen	18
<b>9</b>	<b>Scope of delivery</b>	<b>19</b>
<b>10</b>	<b>Disposal/Recycling</b>	<b>20</b>
<b>11</b>	<b>Product specification</b>	<b>21</b>
11.1	Technical data Sensirion SCD40	21
11.1.1	CO <sub>2</sub> Sensing Performance	21
11.1.2	Humidity Sensing Performance	21
11.1.3	Temperature Sensing Performance	21
<b>12</b>	<b>Appendix</b>	<b>22</b>
12.1	CE declaration of conformity	22

# 1 Introduction

## 1.1 Thank you for purchasing your Condair Cube

The Condair Cube uses a sensor to detect CO<sub>2</sub>, relative humidity and temperature in the ambient environment and is primarily intended for indoor use.

The Condair Cube incorporates the latest technical advances and meets all recognized safety standards. Nevertheless, improper use of the Condair Cube may result in danger to the user or third parties. Further, Condair shall not be liable for any incorrect readings and any damage resulting therefrom.

To ensure a safe, proper, and economical operation of the Condair Cube please observe and comply with all information contained in the present documentation as well as in the separate documentations of the components installed in the Condair Cube.

If you have questions after reading this documentation, please contact your Condair representative. They will be glad to assist you.

## 1.2 Notes on the operation manual

### Limitation

**The subject of this operation manual is the Condair Cube.** The various options and accessories are only described as necessary for proper operation of the equipment.

This operation manual is restricted to the **operation of the** Condair Cube and is meant for **users of this device**.

Please note that some illustrations in this manual may include options and accessories that may not be standard or available in your country. Please check with your Condair representative for availability and specification details.

### Safekeeping

Please keep this operation manual in a safe place, where it can be immediately accessed. If the equipment changes hands, the documentation must be passed on to the new owner

If the documentation gets misplaced, please contact your Condair representative.

### Language versions

This operation manual is available in various languages. Please contact your Condair representative for information.

## 2 For your safety

---

### General

Every person operating the Condair Cube must have read and understood these instructions before use.

Knowledge of the contents of this manual for the Condair Cube is a basic requirement for protecting against any kind of danger, to prevent faulty installations, and to operate the Condair Cube safely and correctly.

All symbols, signs and markings applied to the components of the Condair Cube must be observed and kept in readable state.

### Intended use

The Condair Cube is intended exclusively **for indoor use**. Any other type of application is considered as not conforming with the intended purpose and may lead to deviating results being displayed by the Condair Cube. Any warranty claim will be voided if the device is not used for its intended purpose. Intended use also includes observing all the information contained in this manual.

### Prohibited modifications to the unit

**No modifications must be undertaken** on the Condair Cube without the express written consent of the manufacturer.

For the replacement of defective components only use **original accessories and spare parts** available from your Condair representative.

## 3 Quickstart

1. **Switch on the Condair Cube:** To do this, press the power button inside the cavity on the lower, left side of the cube (see product overview).

**Note:**

When the Condair Cube is plugged in via the USB cable, it switches on automatically. Fully charge the device before using it for the first time.

2. Place the Condair Cube upright in the room where you want to check the room air. The Cube must be placed as shown in the figure below, so that the sensor on the back of the Cube is reached by the room air and the excess heat can escape through the ventilation slots.

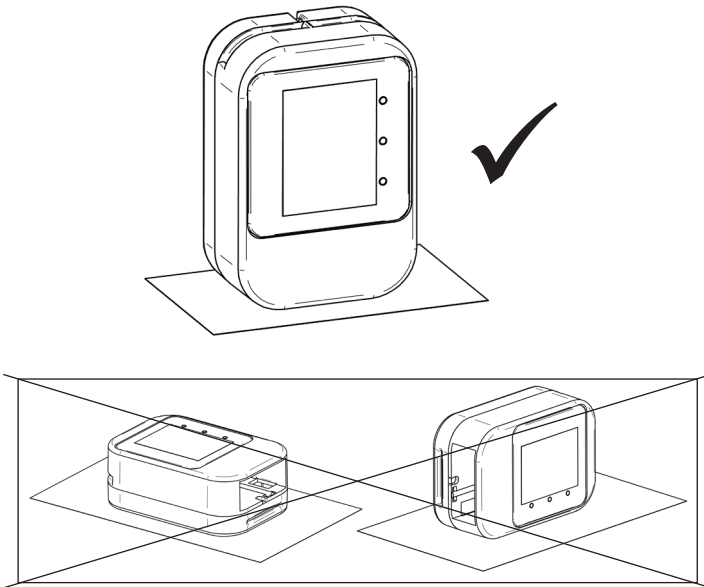

3. Once the Condair Cube is in place, it requires an adjustment time of approx. 20 minutes until all values are displayed correctly. In particular, the temperature may deviate during the first phase after switching on, since the sensor is not yet at operating temperature.
4. When the Condair Cube is put into operation for the first time, it must be calibrated. This procedure is described in [chapter 5](#).

# 4 Product overview

## 4.1 Components

- 1 housing from 2 parts
- Display with rechargeable battery (M5core2)
- Sensor (Sensirion SCD40)
- USB charging cable
- Optional Micro SD card (not included in delivery)

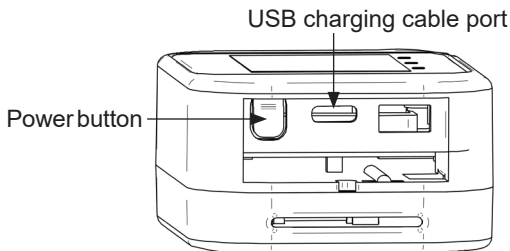
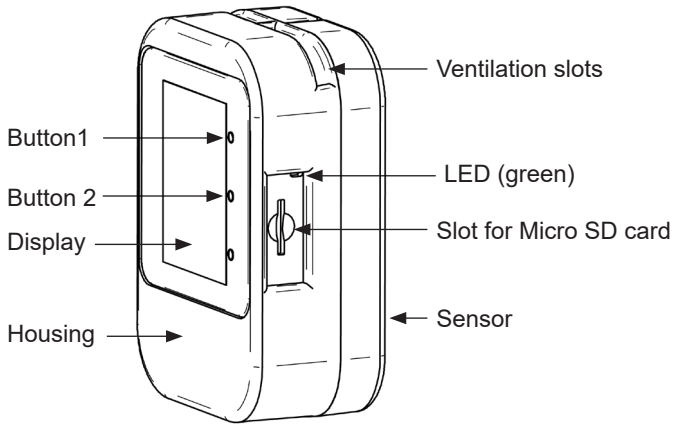

## 4.2 Main screen view

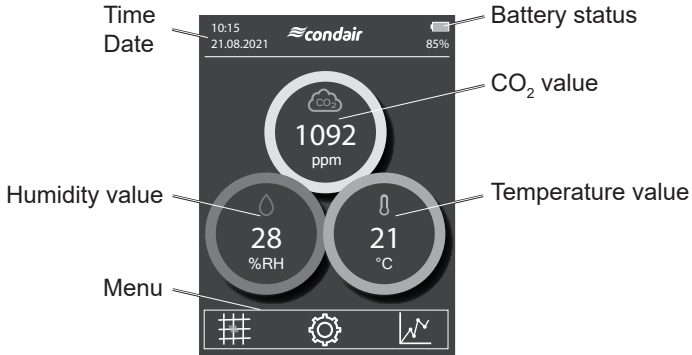

- Time/Date:** Shows the current time and date.
- Battery status:** Shows the current state of charge of the battery. The display ranges from 0-100 %.
- CO<sub>2</sub> value:** Displays the current CO<sub>2</sub> content in the air. The value is given in ppm (parts per million).
- Temperature value:** Displays the current temperature value in °C (Celsius) or in °F (Fahrenheit).
- Humidity value:** Displays the current relative humidity of the ambient air. Indication in %RH.
- Menu bar:** Via the menu bar you can access the various submenus.
- Health chart
  - Settings
  - Graphical view of the temporal courses of CO<sub>2</sub>, humidity and temperature
- Button 1:** Turn on screen and increase brightness
- Button 2:** Turn off screen and reduce brightness
- LED:** When the display is darkened via button 2, the LED lights up green as an operating indicator.



## 4.2.1 Traffic light display of the measured values

The circles around the values show the current state of the value in the manner of a traffic light system:

Green – Healthy (Everything in the optimal range)

Yellow – Acceptable (Caution: Need for action)

Red – Critical (Critical readings)

### CO<sub>2</sub>

Green circle:	CO <sub>2</sub> content of the ambient air is optimal. (value is ≤ 800 ppm)
Yellow circle:	CO <sub>2</sub> content in the ambient air is increased. Ventilation recommended. (value is between > 800 and ≤ 1200 ppm)
Red circle:	CO <sub>2</sub> content in the ambient air is critical. Ventilation necessary. (value is > 1200 ppm)

### Relative humidity

Green circle:	Relative humidity of the ambient air is at an optimum. (value is between ≥ 40 and ≤ 60 % rH)
Yellow circle:	Relative humidity of the ambient air is rather low or rather high. (value is between ≥ 30 and < 40 % rH or > 60 and < 70 % rH)
Red circle:	Relative humidity of the ambient air is too low or too high. (value is < 30 % rH or ≥ 70 % rH)

### Temperature

Green circle:	Comfortable ambient temperature. (value is between ≥ 20 °C and < 23.5 °C) (value is between ≥ 68 °F and < 74.5 °F)
Yellow circle:	Ambient temperature is rather low or high. (value is ≥ 17 and < 20 °C or ≥ 23.5 and < 27 °C) (value is ≥ 62.5 and < 68 °F or ≥ 74.5 and < 80.5 °F)
Red circle:	The comfortable temperature range is undershot or overshot. (value is < 17 °C or ≥ 27 °C) (value is < 62.5 °F or ≥ 80.5 °F)

#### Note:

Please note that the sensor requires an adjustment time of up to 20 minutes after switching on, a reset or when moving to a different location, until the temperature reading is displayed correctly.

## 4.3 Application overviews

### 4.3.1 View health chart

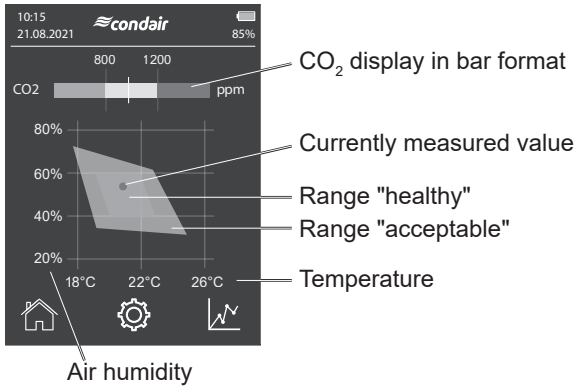

The range "healthy" represents the air quality, which provides increased health protection and is perceived as pleasant.

The ranges "healthy", "acceptable" and "critical" are distinguished.

The aim is that the current measured value (red point) of the room air is in the inner green diamond and thus in the "healthy" range.

In the upper area of the view, the currently measured CO<sub>2</sub> content of the room air is displayed in a bar view. If the current measured value is outside the green range, the room should be ventilated to reduce the CO<sub>2</sub> content in the room.

#### Note:

If the currently measured value is displayed as a gray dot at the edge of the diagram, it indicates that the measured value is outside the displayed range.

### 4.3.2 View historical readings

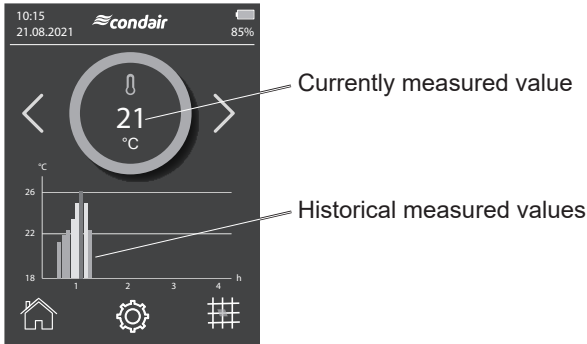

This view shows the course of the measured room temperature over a maximum of 4 hours.

For every 10 minutes of measurement, a bar is displayed which shows the average value measured. This is colored according to the described traffic light system. See chapter [chapter 4.2.1](#). If the bar is yellow or red, the temperature was too low or too high on average over the last 10 minutes, taking the health chart into account.

A 4-hour chart is available for all measured values of CO<sub>2</sub>, temperature and humidity. These views are accessible via the arrow keys on the side of the circle.

### 4.3.3 Settings

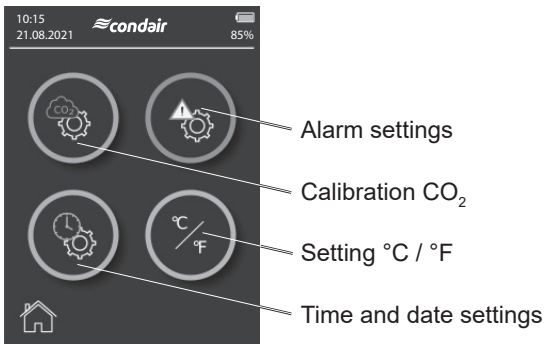

Via the 3 icons you can call the different submenus:

- Alarm settings
- Calibration CO<sub>2</sub>
- Setting °C / °F
- Time and date settings

Tap once on the respective icon to enter the submenus.

## 5 Calibration

For accurate measurement results of the CO<sub>2</sub> content, the Condair Cube must be calibrated regularly. Two different calibration options are available:

- Auto calibration
- Manual calibration

### 5.1 Manual Calibration

To calibrate the sensor manually, proceed as follows:

1. Menu → Settings → Calibration CO<sub>2</sub>

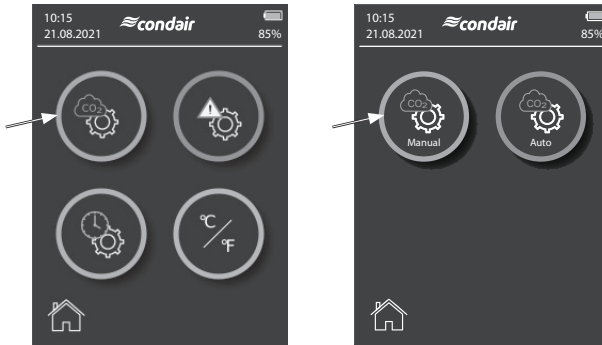

2. Place the sensor outdoors, for example outside the window in fresh air. Outside air is used as a reference, since it normally has a value of approx. 400 ppm.

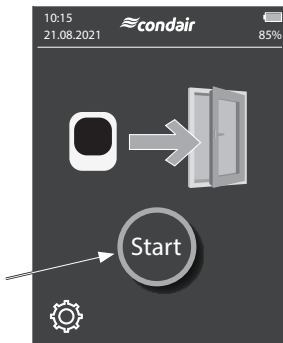

3. Press "Start" to start calibration.

- The measurement takes approx. 3 minutes This is displayed graphically with a bar graph and a percentage. The sensor resets its CO<sub>2</sub> value several times during this time.

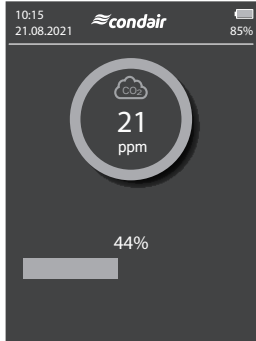

- After the calibration is completed, the Cube automatically switches to the main page.

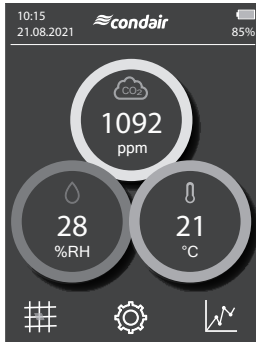

- Check the CO<sub>2</sub> value. If it is within the range of 400 +/-25 ppm, the calibration was successful. If the value is above or below this, repeat the calibration.

**Important:**

The sensor must be calibrated during the first start-up.

Also, if you place the Cube in a new geographical location, it must be recalibrated for accurate measurement results.

## 5.2 Auto calibration

By default, the auto calibration is activated, whereby the sensor calibrates its value independently. **It is important here that the sensor is in operation as permanently as possible and is exposed to fresh outside air at least once a week (approx. 10 min).**

**During auto-calibration, the lowest measured value over one week is taken as the reference value and recalibrated to 400 ppm.**

**Note:** This setting is also saved when the cube is switched off.

1. Menu → Settings → Calibration CO<sub>2</sub>
2. Auto calibration
3. Enable or disable auto calibration

If the Condair Cube is not operated permanently and a weekly 10 min fresh air supply cannot be guaranteed, it is recommended to deactivate the auto calibration and to perform the manual calibration.

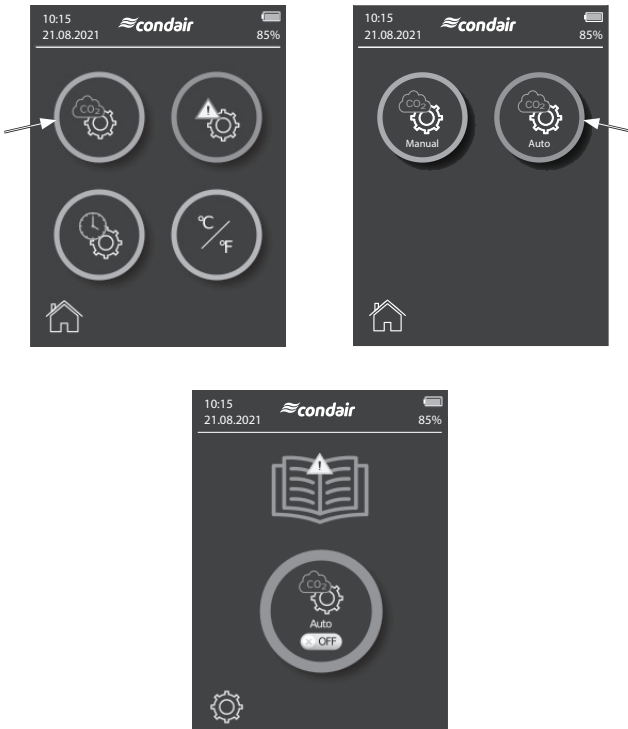

## 6 Time and date setting

The Condair Cube has an internal RTC (RealTimeClock) which is used for the time and date display. Time and date run for approx. 2 months when the unit is switched off and without charging the Cube. Afterwards, both must be reset.

Follow the procedure below to reset the time and date:

1. Menu → Settings → Time and date settings

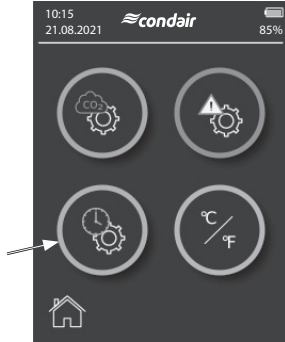

2. Set the desired time using the up/down arrow keys.  
The time format is defined as follows:  
hh:mm:ss (Hours:Minutes:Seconds)



3. Confirm the entry with "Ok".

4. Enter the desired date in the next screen.  
The date format is defined as follows:  
dd:mm:yy (Day:Month:Year)



5. Confirm the entry with "Ok" to complete the date entry.



# 7 Conversion degrees Celsius / degrees Fahrenheit

The Condair Cube can display the temperature in either degrees Celsius or degrees Fahrenheit.

1. Menu → Settings → Setting degrees Celsius / degrees Fahrenheit

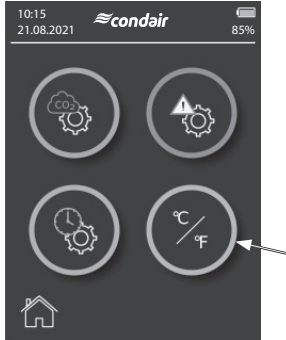

2. Switch between degrees Celsius / degrees Fahrenheit by pressing the icon. The set value is displayed in the lower gray box with °C or °F.



# 8 Options

## 8.1 SD card

An optional memory card can be integrated via the SD card slot on the right side of the Cube. If a memory card is detected during the start-up process, the measured values are saved to the memory card every minute. With the help of Excel, this data can be displayed and analyzed.

**Recommended memory card:**

SANDISK microSDXC 16GB+AD memory card (16 GB, 98 MB/s, grey/red) or similar.

## 8.2 Power bank

To extend the battery life of the Condair Cube, you can use any power bank with a 5V USB connection.

## 8.3 Display on large screen

It is possible to connect the Condair Cube to an external monitor via a PC. To do this, connect the Condair Cube to the PC via the USB cable and install the necessary drivers. Then open the Condair Cube Tool to start the display on an external monitor. The values are updated at intervals of 30 seconds.

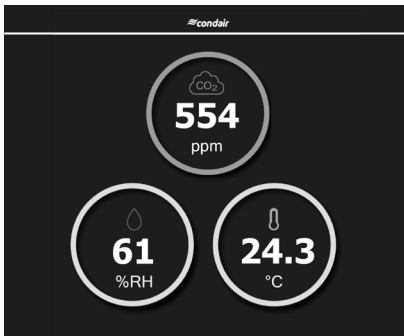

**Note:**

The minimum resolution for correct display of the values is 1024x768. Note that individual setting of zoom factors may have the negative effect on the display.

## 9 Scope of delivery

---

- Condair Cube
- USB charging cable
- Quick guide

## 10 Disposal/Recycling

---

Components no longer in use cannot be disposed in domestic waste. Please dispose of the individual components in accordance with local regulations at the authorised collecting point.

If you have any questions, please contact the responsible authority or your local Condair representative.

Thank you for your contribution to environmental protection.

# 11 Product specification

## 11.1 Technical data Sensirion SCD40

### 11.1.1 CO<sub>2</sub> Sensing Performance

Default conditions of 25 °C, 50 % RH, ambient pressure 1013 mbar, default periodic measurement and 3.3 V supply voltage apply to values in the table below, unless otherwise stated.

Parameter	Conditions	Value
CO <sub>2</sub> output range	–	0 – 40'000 ppm
CO <sub>2</sub> measurement accuracy	400 ppm – 2'000 ppm	± (75 ppm + 5 % of reading)
Accuracy drift per year with automatic selfcalibration algorithm enabled	Typical	± (5 ppm + 0.5 % of reading)

### 11.1.2 Humidity Sensing Performance

Parameter	Conditions	Value
Humidity measurement range	–	0 % RH – 100 % RH
Accuracy (typ.)	15 °C – 35 °C, 20 % RH – 65 % RH	± 6 % RH
	-10 °C – 60 °C	± 9 % RH
Accuracy drift	–	< 0.25 % RH / year

### 11.1.3 Temperature Sensing Performance

Parameter	Conditions	Value
Temperature measurement range	–	-10 °C – 60 °C
Accuracy (typ.)	15 °C – 35 °C	± 1 °C
	-10 °C – 60 °C	± 1.5 °C
Accuracy drift	–	< 0.03 °C / year

# 12 Appendix

## 12.1 CE declaration of conformity



---

# EC

Konformitätserklärung	Declaration of conformity	Déclaration de conformité
Wir, Condair Group AG CH-8808 Pfäffikon SZ erklären in alleiniger Verantwortung, dass das Produkt	We, Condair Group AG CH-8808 Pfäffikon SZ declare under our sole responsibility, that the product	Nous, Condair Group AG CH-8808 Pfäffikon SZ déclarons sous notre seule responsabilité, que le produit
<b>Condair Cube</b>		
auf das sich diese Erklärung bezieht, mit den folgenden Normen oder normativen Dokumenten übereinstimmt	to which this declaration relates is in conformity with the following standards or other normative standards	auquel se réfère cette déclaration est conforme aux normes ou autres documents normatifs
EN 55032 EN 61000-3-2 EN 61000-3-3 EN 301489-1 V2.2.3 EN 301489-17 V3.2.3 EN 300328 V2.2.2		
und den Bestimmungen der folgenden Richtlinien entspricht	and is corresponding to the following provisions of directives	et est conforme aux dispositions des directives suivantes
RED-Richtlinie 2014/53/EU EMC-Richtlinie 2014/30/EU ROHS Neufassung der Richtlinie 2011/65/EG	RED directive 2014/53/EU EMC directive 2014/30/EU ROHS recast directive 2011/65/EC	Directive RED 2014/53/EU Directive EMC 2014/30/EU Directive de refonte ROHS 2011/65/CE

---

Pfäffikon, September 01, 2021

Condair Group AG



Eric Roth  
Head of Engineering



Adrian Spörri  
Corporate Systems Manager

Condair Group AG  
Gwattstrasse 17  
8808 Pfäffikon, Switzerland  
Tel. +41 55 416 61 11, Fax +41 55 588 00 07  
info@condair.com, www.condairgroup.com

2803018 DE/EN/FR 2109

**Notes**



CONSULTING, SALES AND SERVICE:



CH94/0002.00

Condair Group AG  
Gwattstrasse 17, 8808 Pfäffikon SZ, Switzerland  
Phone +41 55 416 61 11, Fax +41 55 588 00 07  
info@condair.com, www.condairgroup.com

